



## ASSEMBLY INSTRUCTION

DELUCA 2.5 SEATER

ITEM CODE 66138

Imported by Amart Furniture Pty Ltd, Qld, Brisbane Australia.

For any assistance with assembly or for missing parts please phone

Amart Furniture, Customer Service Free call 1800 351 084

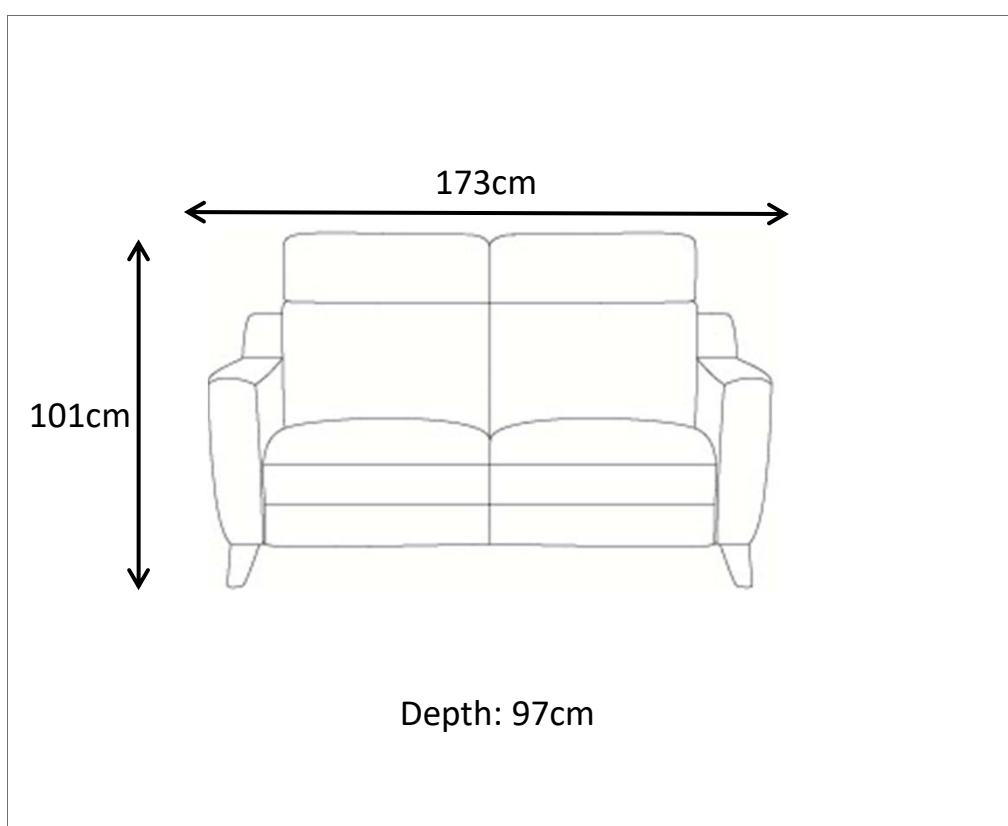

Imported by Amart Furniture Pty Ltd, Qld, Brisbane Australia.



For any assistance with assembly or for missing parts please phone

Amart Furniture, Customer Service Free call 1800 351 084

## PRE-ASSEMBLY PREPARATION

### Before you start:

1. Choose a clean, level, spacious assembly area. Avoid hard surfaces that may damage the product
2. Take care when lifting. Product should be assembled as near as possible to the point of use
3. Ensure that you have all required contents for complete assembly
4. Always read the assembly instructions carefully before beginning assembly.
5. Keep all hardware parts and packaging out of reach of small children.
6. Do not over tighten the screws and bolts as this may damage the threads

	
ALLOW 15MINUTES	PEOPLE REQUIRED
ADDITIONAL TOOLS REQUIRED	



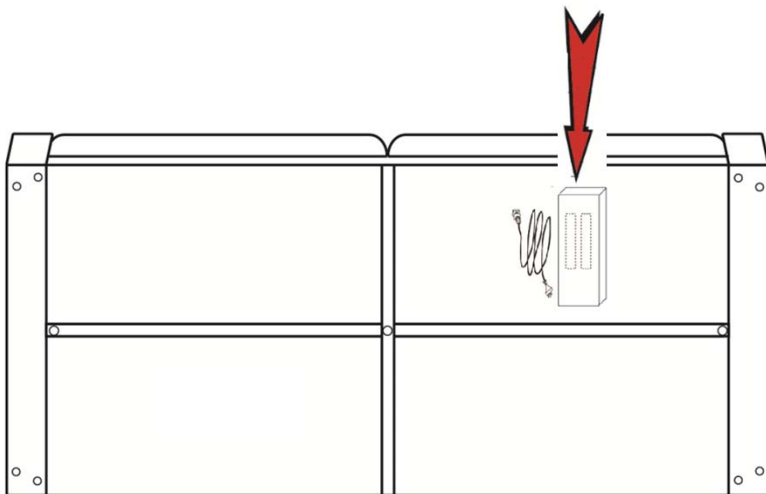

### **WARNING**

- Do Not allow children to play on this mechanised furniture or operate the mechanism. Leg rest folds down on closing so that a child could possibly be injured. Always leave in an upright and closed position. Keep hands and feet clear of mechanism. Only the occupant should operate it.

Step1: Locate package of sofa legs, power cord and hardware that are attached to the bottom of sofa.

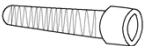

 With 2 people carefully turn onto back on piece of cardboard or carpet to protect covering

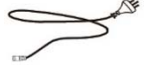
 Bolt M8X40 9pcs	 Washer 9pcs	 Hexagon key 1pcs	 Timber leg 4pcs	 Plastic leg 1pcs	 Power cord 1pcs
--	--	---	--	---	--

STEP2: Take out 4 timber legs, then use hexagon key to fasten the timber legs to the holes at bottom of sofa with bolts and washers.

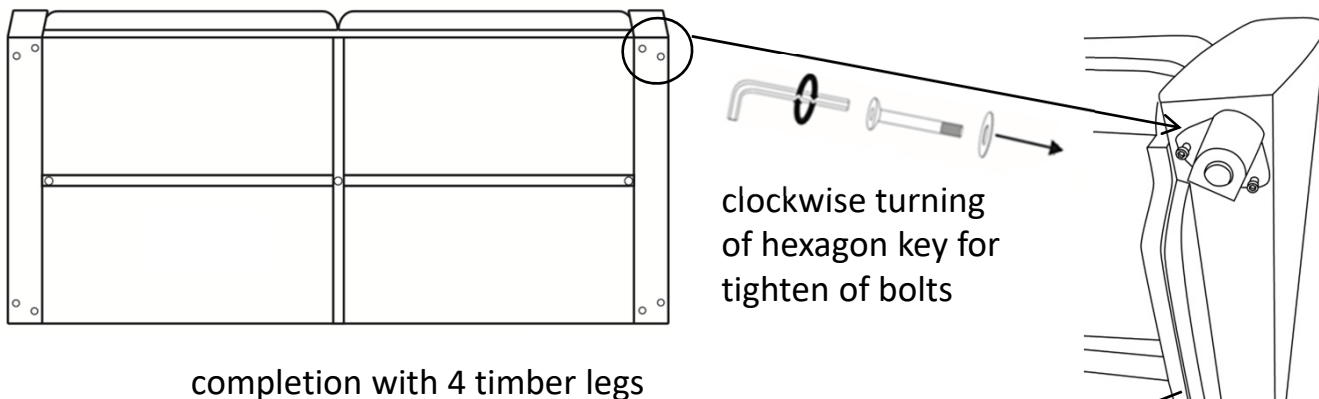

completion with 4 timber legs

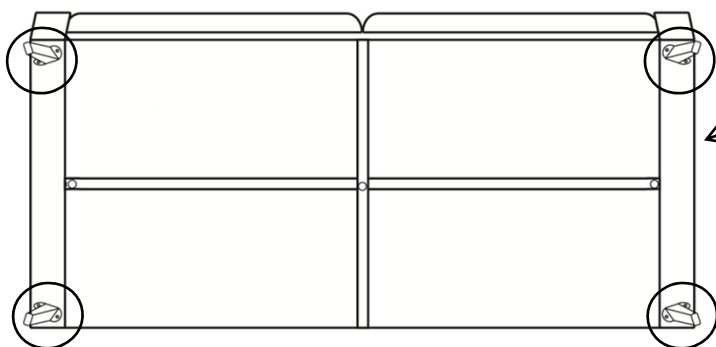

Step3: Take out plastic leg, then use hexagon key to fasten the plastic leg to the centre at bottom of sofa with bolts and washers.

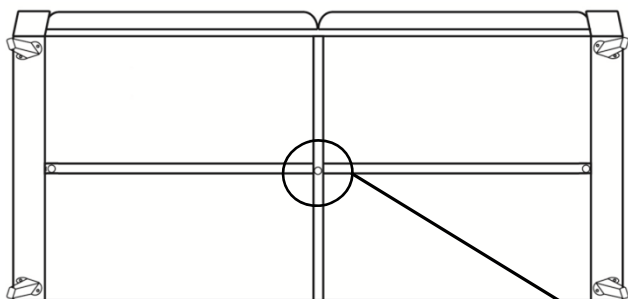

clockwise turning  
of hexagon key for  
tighten of bolts



**IMPORTANT NOTE**

**Adding the centre support leg is very important for this range.**

Failing to do this will cause your lounge to sag in the middle which can cause mech misalignments and cause your footrest to come into contact with the floor, resulting in permanent and irreparable damage to your leather.

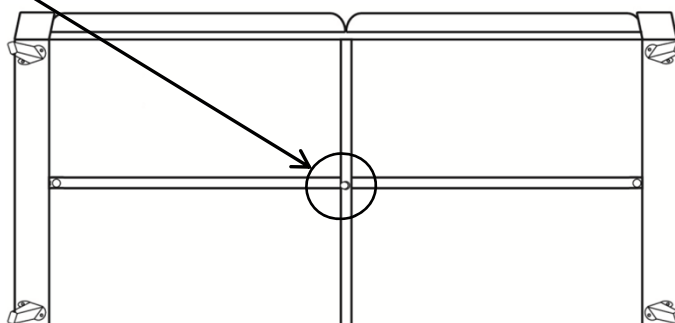

Step4: Slide back receivers into steel mechanism posts in the base of the furniture, and then press both sides of the each back firmly into place to ensure each back automatically locks in place.

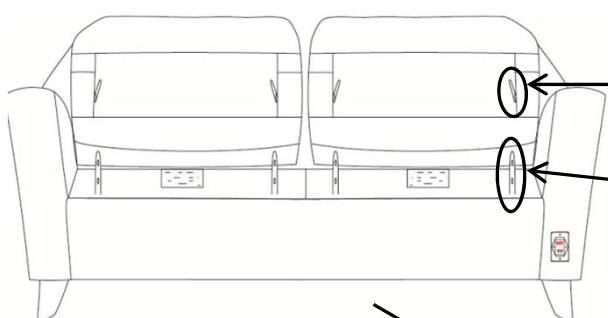

Receiver at bottom  
of back rest

Mechanism post at  
rear of seat

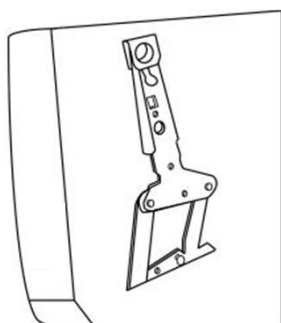

slide receiver  
into post

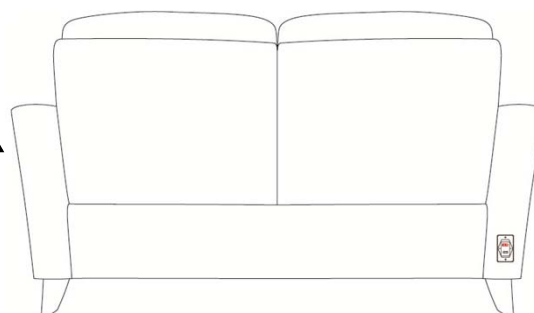

Step5: Plug power cable into socket at back of electric seat.

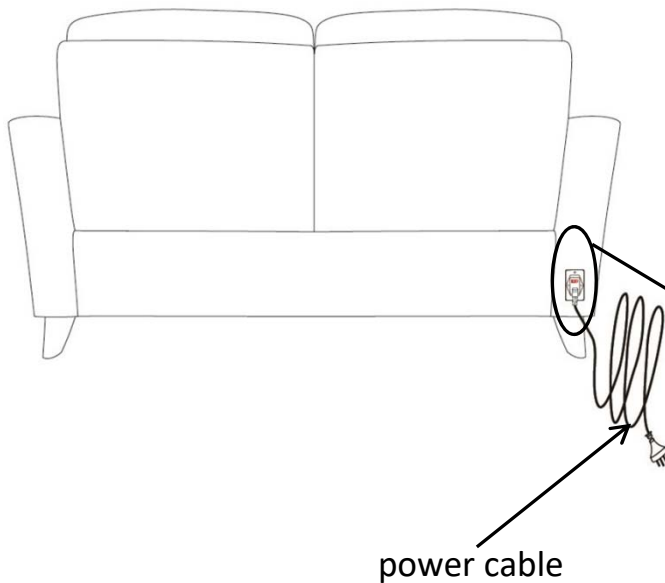

**Safety Note: Power cable is not to be placed under or within the recliner structure.**

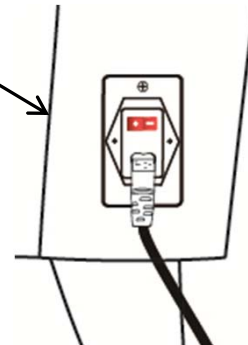

ASSEMBLY IS COMPLETE

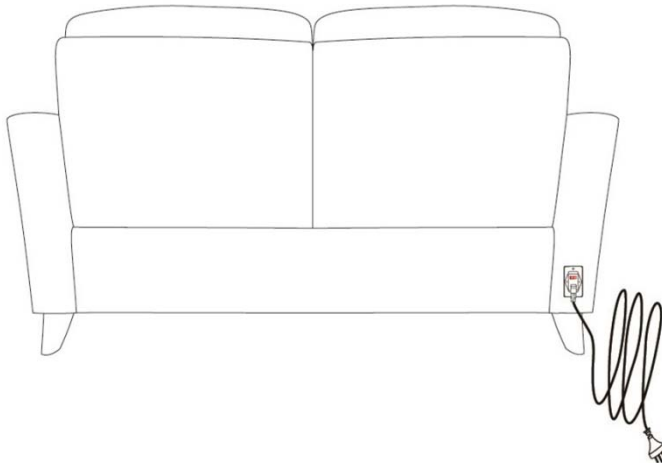

**SAFETY NOTE:**  
**PLEASE ENSURE THAT ALL ELECTRICAL CORDS AND CABLES ARE CLEAR OF THE FRAME AND MECHANISM. A FAILURE TO DO SO MAY SEVER YOUR POWER CORD RESULTING IN SERIOUS INJURY OR DEATH.**

## **READ THESE INSTRUCTIONS THOROUGHLY BEFORE USE:**

### **DANGER:** TO REDUCE THE RISK OF ELECTRIC SHOCK:

Always unplug from electric outlet before cleaning.

### **WARNING:** RISK OF INJURY

Keep children away from extended footrest and any moving parts.

**CAUTION:** Do not allow children to play on this electric recliner or operate the powered mechanism. The leg rest folds when closing and could possibly cause injury to a child. Always leave the recliner in an upright and closed position when not in use. Keep hands and feet clear of mechanism. Only the occupant should operate it.

### **POWER CORD SAFETY**

**WARNING:** Unplug and remove power cord from wall when not in use and store out of reach of children.

Take care when moving recliner that wall and transformer cords are not under the base or they may get damaged.

**- NEVER OPERATE ELECTRIC RECLINER IF IT HAS A DAMAGED CORD OR PLUG.**

**WARNING:** TO REDUCE RISK OF BURNS, FIRE, ELECTRIC SHOCK OR PERSONAL INJURY TO PERSONS:

- Use only for its intended purpose
- Never press or activate control switch if you are not seated in recliner
- Only the occupant should activate the control switch
- Never operate with more than one person occupying seat
- Never sit or stand on the footrest

## CARE AND MAINTENANCE

### FABRIC CARE

REGULAR CARE: PROTECT FROM DIRECT SUNLIGHT.  
VACUUM REGULARLY USING LOW SUCTION.  
ROTATE REVERSIBLE CUSHIONS REGULARLY.

#### CLEANING:

DO NOT REMOVE CUSHION COVERS FOR SEPARATE  
CLEANING EVEN THOUGH THEY HAVE ZIPPERS.

DO NOT WASH

DO NOT DRY CLEAN

DO NOT SHAMPOO CLEAN

CLEAN WITH HOT-WATER EXTRACTION MACHINE.

(HOT) PROFESSIONAL CLEANING RECOMMENDED

DO NOT USE DISHWASHING OR LAUNDRY

DETERGENTS

USE ONLY UPHOLSTERY DETERGENTS

DO NOT WET FILLING

DRY IN SHADE AWAY FROM DIRECT HEAT AND

SUNLIGHT

ALLOW TO DRY THOROUGHLY BEFORE RE-USE

#### SPOT CLEANING:

DO NOT RUB

DO NOT SPOT CLEAN WITH ANY SOLVENT.

TREAT SPILLS AND STAINS AS SOON AS POSSIBLE.

GENTLY SCRAPE ANY SOIL OR MOP ANY LIQUID

FROM THE SURFACE OF THE FABRIC.

APPLY PROPRIETARY CLEANING AGENTS STRICTLY

ACCORDING TO INSTRUCTIONS TO REMOVE THE

RESIDUE OF THE SPILL.

DO NOT SATURATE THE FABRIC OR INTERIOR WITH

WATER OR OTHER CLEANING LIQUIDS.

WARNING: APPLY ONLY WATER-BASED SOIL RESIST

(FABRIC PROTECTION) TREATMENTS. DO NOT USE

AEROSOL PRODUCTS.